



Low thermal inertia



Low water content



Versatility



Easy to stock and install



Maximum working pressure



3 international patents



SIDE KIT, AVAILABLE ON REQUEST
AS AN ACCESSORY (AVAILABLE IN WHITE
RAL 9010 ONLY)



Standard supply	500: from 3 to 14 sections
Colours	RAL 9010 White
Maximum working pressure	16 bar
Test pressure	24 bar

All models **Blitz B3** are guaranteed **10 years** from installation date on manufacturing faults, provided that the installation has been performed in compliance with the current norms and respecting the instructions relating to the installation, the correct use and the correct maintenance as illustrated on this catalogue.

Model	Heat output				
	ΔT 30	ΔT 40	ΔT 50	ΔT 60	ΔT 70
	W/sect.	W/sect.	W/sect.	W/sect.	W/sect.
500/100	62,3	89,9	119,5	150,8	183,6

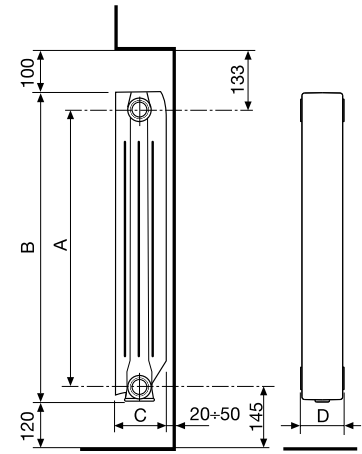







MEASURES EXPRESSED IN MILLIMETRES

Model	Code	Depth	Height	Centre distance	Length	Connection diameters	Water capacity	Exponent	Coefficient
		(C) mm	(B) mm	(A) mm	(D) mm	inches	litres/sect.	n	Km
500/100	V659034	97	557	500	80	G1	0,26	1,2767	0,8097

Maximum working pressure: 1600 kpa (16 bar) Maximum working temperature: 120 °C

Characteristic equation of the model $\Phi = Km \Delta T^n$

The thermal efficiency values shown comply with the European Standard EN 442-1:2014 and are certified by the MRT Lab of the Milan Polytechnic, notified body N°1695.

Item	Description	Code
	A 80 The radiator fixing kit includes: 2 Rh G 1/2" adapters; 2 Lh G 1/2" adapters, galvanized and painted; 4 sealing gaskets; 1 G 1/2" manual bleed valve with seal; 1 G 1/2" blind plug with seal	550103
	A 81 The radiator fixing kit includes: 2 Rh G 1/2" adapters; 2 Lh G 1/2" adapters, galvanized and painted; 4 sealing gaskets; 1 G 1/2" manual bleed valve with seal; 1 G 1/2" blind plug with seal; 3 brackets	550104
	A 2/1 RH/LH G 1" Nipple	510011
	A 10/1 1" Seals for nipples (without asbestos)	530105
	A 11/1 1" Seals for plugs (without asbestos)	530108
	A 20 Kit with two adjustable coated brackets	550037
	- Side kit 500 mm - Colour: White RAL 9010	550361

For other accessories, see from page 73